

EE-SX770/771/772/870/871/872(A/P/R)



Thin, Compact Photomicrosensor with Attached Cable

- Next generation design available with NPN or PNP output
- Allows standard M3-screw mounting
- Twenty-four models available in standard, L-shaped, and T-shaped
- UL, EMC and CE approvals
- Each model equipped with a flexible cable that conforms to machine contours
- Compact size allows high-density mounting
- Indicators are visible from both sides
- Readily-visible, molded workpiece insertion mark allows fine-tuning of sensing position

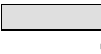
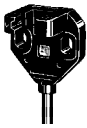
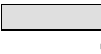

Ordering Information

The operation indicator of models with suffix code (A) or (R) will turn ON when the light is interrupted.

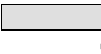
| Appearance | Sensing method | Sensing distance | Output configuration | | Part number |
|---|----------------|--|----------------------|----------|-------------|
| Standard  | Slot |  5 mm (0.2 in) (slot width) | NPN | Dark-ON | EE-SX770 |
| | | | | | EE-SX770A |
| | | | PNP | Dark-ON | EE-SX770P |
| | | | | | EE-SX770R |
| | | | NPN | Light-ON | EE-SX870 |
| | | | | | EE-SX870A |
| | | | PNP | Light-ON | EE-SX870P |
| | | | | | EE-SX870R |
| L-shaped  | Slot |  5 mm (0.2 in) (slot width) | NPN | Dark-ON | EE-SX771 |
| | | | | | EE-SX771A |
| | | | PNP | Dark-ON | EE-SX771P |
| | | | | | EE-SX771R |
| | | | NPN | Light-ON | EE-SX871 |
| | | | | | EE-SX871A |
| | | | PNP | Light-ON | EE-SX871P |
| | | | | | EE-SX871R |
| T-shaped  | Slot |  5 mm (0.2 in) (slot width) | NPN | Dark-ON | EE-SX772 |
| | | | | | EE-SX772A |
| | | | PNP | Dark-ON | EE-SX772P |
| | | | | | EE-SX772R |
| | | | NPN | Light-ON | EE-SX872 |
| | | | | | EE-SX872A |
| | | | PNP | Light-ON | EE-SX872P |
| | | | | | EE-SX872R |

Specifications

| | | | | | | | | |
|--|---|-------------------------------------|-------------------------------------|-------------------------------------|----------------------------------|-------------------------------------|-------------------------------------|-------------------------------------|
| Item | Through-beam models(slot) | | | | | | | |
| Output configuration | Dark-ON | | | | Light-ON | | | |
| Output type | NPN | | PNP | | NPN | | PNP | |
| Model | EE-SX770 EE-SX771 EE-SX772 | EE-SX770A EE-SX771A EE-SX772A | EE-SX770P EE-SX771P EE-SX772P | EE-SX770R EE-SX771R EE-SX772R | EE-SX870 EE-SX871 EE-SX872 | EE-SX870A EE-SX871A EE-SX872A | EE-SX870P EE-SX871P EE-SX872P | EE-SX870R EE-SX871R EE-SX872R |
| Supply voltage | 5 to 24 VDC \pm 10%, ripple (p-p): 10% max | | | | | | | |
| Current consumption | NPN models | 35 mA max. | | | | | | |
| | PNP models | 30 mA max. | | | | | | |
| Slot width | 5 mm | | | | | | | |
| Standard target object | Opaque: 2 x 0.8 mm min | | | | | | | |
| Differential travel | 0.025 mm | | | | | | | |
| Control output | NPN open collector output models: At 5 to 24 VDC: 100 mA load current (I_C) with a residual voltage of 0.8 V max. When driving TTL: 40 mA load current (I_C) with a residual voltage of 0.4 V max. PNP open collector output models: At 5 to 24 VDC: 50 mA load current (I_C) with a residual voltage of 1.3 V max. | | | | | | | |
| Operation indicator (See Note 1.) | Red LED is ON when the object to be detected is not present | | | | | | | |
| Response frequency (See Note 2.) | 1 kHz | | | | | | | |
| Light source | GaAs infrared LED with a peak light wavelength of 940 nm | | | | | | | |
| Protective circuit (See Note 3.) | Overcurrent protection (built-in circuit) | | | | | | | |
| Ambient illuminance | Sensing surface: 1,000 lx max with fluorescent light | | | | | | | |
| Ambient temperature | Operating | -25°C to 55°C (-13°F to 131°F) | | | | | | |
| | Storage | -30°C to 80°C (-22°F to 176°F) | | | | | | |
| Ambient humidity | Operating | 5% to 85% | | | | | | |
| | Storage | 5% to 95% | | | | | | |
| Vibration resistance | Destruction: 20 to 2,000 Hz, 1.5-mm double amplitude for 2 hours each in X, Y, and Z directions | | | | | | | |
| Shock resistance | Destruction: 500 m/s ² (50G), three times each in X, Y, and Z directions | | | | | | | |
| Degree of protection | IEC60529 IP60 | | | | | | | |
| Connection method (standard length) | Pre-wired: 2 m | | | | | | | |
| Casing material | PBT (polybutylene terephthalate) | | | | | | | |
| Cable material | PVC (polyvinyl chloride resin) | | | | | | | |

- Note: 1. The operation indicator of models with suffix code (A) or (R) will turn ON when the light is interrupted.
2. The response frequency is a value obtained when the EE-SX detects a rotating disc with holes in it, as shown to the right.
3. Operates when the load current exceeds the rated value of 100 mA to inhibit a current flow exceeding 120 mA.

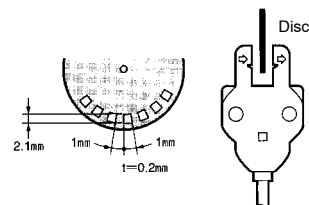

Engineering Data

■ SENSING POSITION (EE-SX77/87)

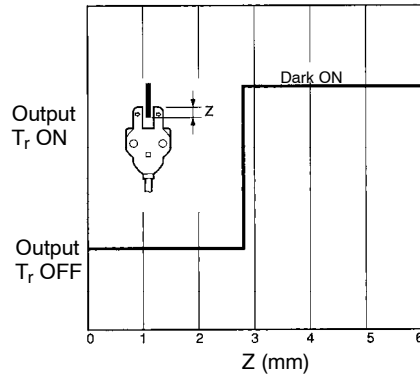
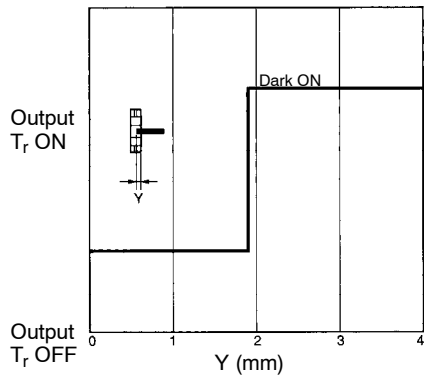

■ REPEATED SENSING POSITION CHARACTERISTICS (TYPICAL)

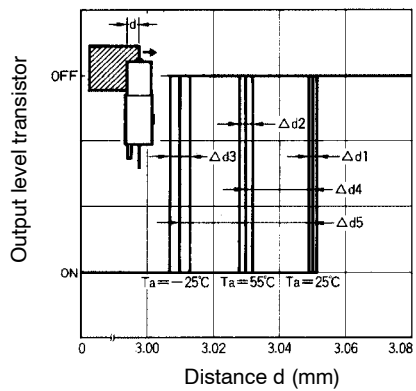

No. of repetitions: 20 at $V_{CC} = 12\text{ V}$

- $\Delta d1 = 0.002\text{ mm}$
- $\Delta d2 = 0.004\text{ mm}$
- $\Delta d3 = 0.005\text{ mm}$
- $\Delta d4 = 0.02\text{ mm}$
- $\Delta d5 = 0.04\text{ mm}$

Operation

■ OUTPUT CIRCUITS

| Output configuration | Model | Output transistor operation | Timing Charts | Output Circuit |
|----------------------|--|-----------------------------|---------------|----------------|
| NPN Output | EE-SX770 EE-SX771 EE-SX772 EE-SX770A EE-SX771A EE-SX772A | Dark-ON | | |
| | EE-SX870 EE-SX871 EE-SX872 EE-SX870A EE-SX871A EE-SX872A | Light-ON | | |
| PNP Output | EE-SX770P EE-SX771P EE-SX772P EE-SX770R EE-SX771R EE-SX772R | Dark-ON | | |
| | EE-SX870P EE-SX871P EE-SX872P EE-SX870R EE-SX871R EE-SX872R | Light-ON | | |

Dimensions

Unit: mm (inch)

STANDARD MODELS

- | | |
|-----------|-----------|
| EE-SX770 | EE-SX870 |
| EE-SX770A | EE-SX870A |
| EE-SX770P | EE-SX870P |
| EE-SX770R | EE-SX870R |

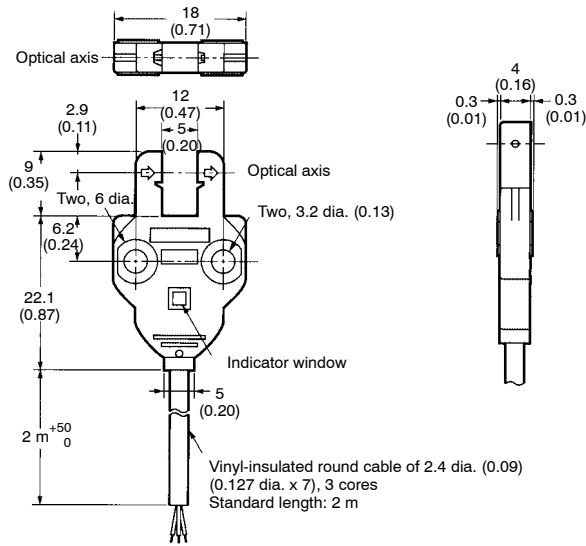
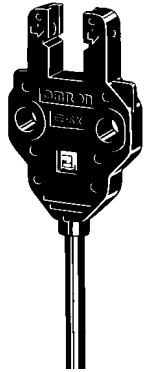

L-SHAPED MODELS

- | | |
|-----------|-----------|
| EE-SX771 | EE-SX871 |
| EE-SX771A | EE-SX871A |
| EE-SX771P | EE-SX871P |
| EE-SX771R | EE-SX871R |

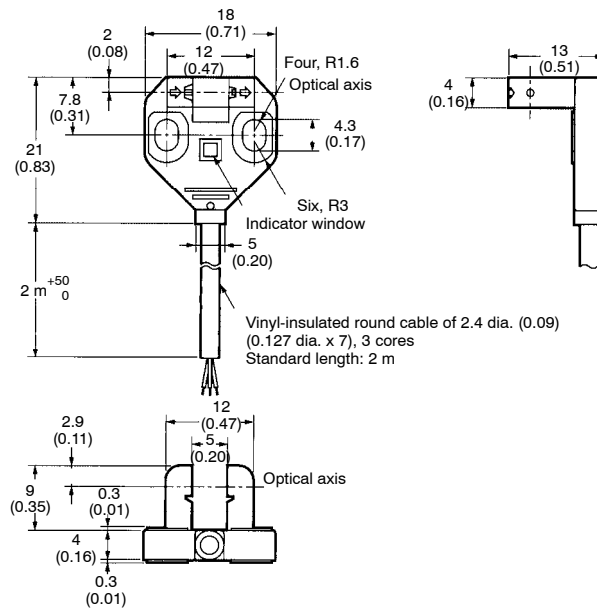
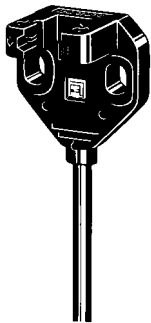

■ T-SHAPED MODELS

- | | |
|-----------|-----------|
| EE-SX772 | EE-SX872 |
| EE-SX772A | EE-SX872A |
| EE-SX772P | EE-SX872P |
| EE-SX772R | EE-SX872R |

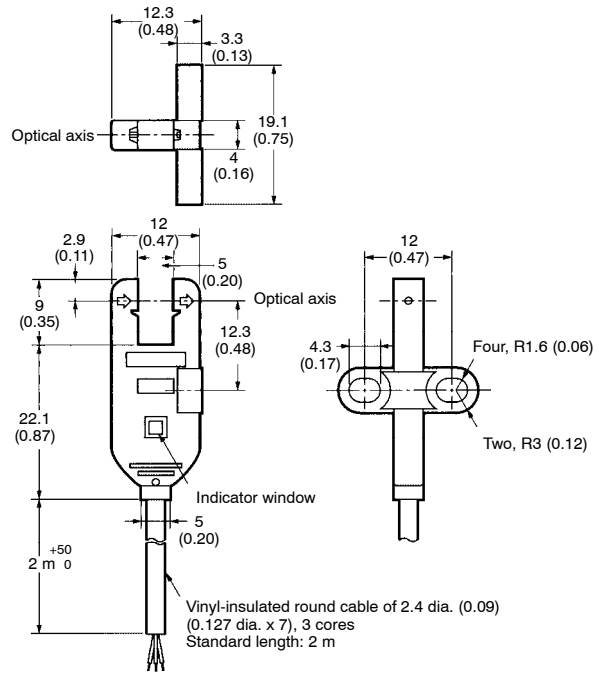
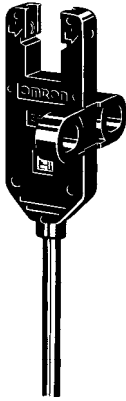

Precautions

■ MOUNTING

- The EE-SX77/87 is a photomicrosensor that should be built into equipment. For this reason, no special protective measures have been taken to protect the EE-SX77/87 from external light disturbance. Avoid malfunction by ensuring that the EE-SX77/87 is not influenced by incandescent lamps or other light sources that may cause external light disturbance.
- Mount the photomicrosensor securely to flat plates. The characteristics of the through-beam sensor change if the slot is deformed.
- Use M3 screws when mounting the EE-SX77/87. Be sure to use spring washers with the screws, so that the screws will not loosen. The tightening torque applied to each screw must be no more than 0.59 N • m (6 kgf • cm).
- Make sure that nothing will come into contact with the sensing element of the sensor. If the sensing element has scratch damage, the operating characteristics of the photomicrosensor will decrease.
- Securely mount the EE-SX77/87 to prevent loosening by vibration or shock.

■ OPERATING ENVIRONMENT

- *Do not* connect the EE-SX77/87 while power is applied, or the EE-SX77/87 may be damaged.
- *Do not* install the EE-SX77/87 in the following locations to avoid malfunction or damage:
 - A. Locations with excessive dust
 - B. Locations with corrosive gas
 - C. Locations where water, oil, or chemicals are directly sprayed
 - D. Locations exposed to direct sunlight
- Make sure that the operating ambient temperature is within the rated range.
- The photomicrosensor may be soluble in organic solvent, acid, and alkaline, aromatic hydrocarbon, and chlorinated aliphatic hydrocarbon solvents. The characteristics of the photomicrosensor may decrease as a result. Make sure that the photomicrosensor is free from these solutions.

⚠ Caution

■ TO AVOID DAMAGE

- Do not use the EE-SX77/87 at voltage exceeding the rated voltage range.

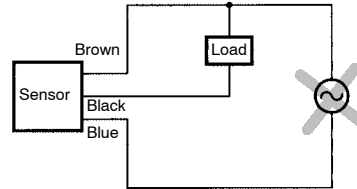

- Do not make mistakes in wiring, such as mistakes in polarity.

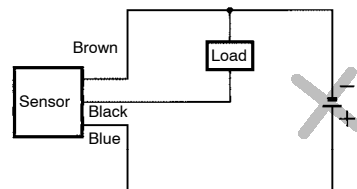

- Do not short-circuit the load (i.e., do not connect a power supply directly to the Sensor) as shown below.

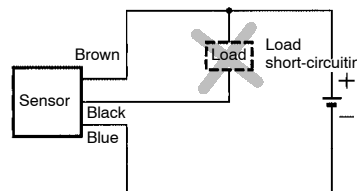

WIRING

For Surge Prevention

If the power supply has surge voltage, connect a Zener diode withstanding 30 to 35 V or a 0.1 to 1-μF capacitor in parallel to the power supply to absorb the surge voltage.

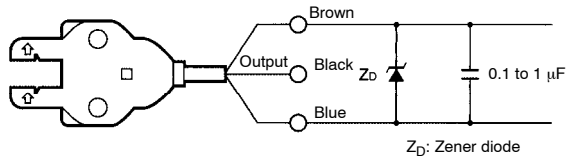

If the load is a relay or other small inductive load, connect it to the EE-SX77/87 as shown below. You must connect a diode for counter-voltage absorption.

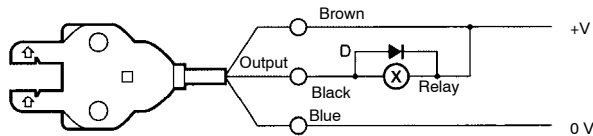

Do not route power lines or high-tension lines in the same conduit with the EE-SX77/87 to avoid damage or malfunction due to induction.

Voltage Output

A photomicrosensor with open collector output can be connected to a device with voltage-input specifications by connecting a resistor between the power supply and output terminals, as shown in the following circuit diagram. The value of the resistor is normally 4.7 kΩ and must withstand a power of 0.5 W at 24 V and 0.25 W at 12 V.

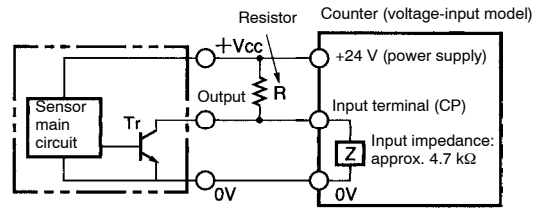

- **EE-SX77/87 series NPN models with a 4.7-kΩ resistor.**

High level:

$$\text{Input voltage } (V_H) = \frac{Z}{R+Z} V_{CC} = \frac{4.7 \text{ k}}{4.7 \text{ k} + 4.7 \text{ k}} \times 24 \text{ V} = 12 \text{ V}$$

Low level:

$$\text{Input voltage } (V_L) \leq 0.4 \text{ V}$$

$$\text{Load current } (I_C) = \frac{V_{CC}}{R} = \frac{24 \text{ V}}{R} = 5.1 \text{ mA} \leq 100 \text{ mA}$$

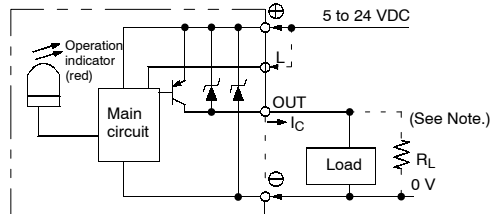

Note: When using a voltage output, always insert a resistor in R_L.

Note: Refer to the ratings of the photomicrosensor for the relationship between the residual voltage and load current.

NOTE: DIMENSIONS SHOWN ARE IN MILLIMETERS. To convert millimeters to inches divide by 25.4.

OMRON[®]
OMRON ELECTRONICS LLC
 One East Commerce Drive
 Schaumburg, IL 60173
1-800-55-OMRON

OMRON ON-LINE
 Global - <http://www.omron.com>
 USA - <http://www.omron.com/oei>
 Canada - <http://www.omron.com/oci>

OMRON CANADA, INC.
 885 Milner Avenue
 Toronto, Ontario M1B 5V8
416-286-6465