

PrimeLock[®] Fitting Bench Top Insertion Tool

*Insert installation instructions for
1/4", 3/8", 1/2", 3/4", and 1" sizes*

INSTRUCTIONS

PrimeLock[®] Fitting

1. Verify the tool is properly set up. Lift the black adjustment knob and slide the head assembly to position "A". Release the knob.

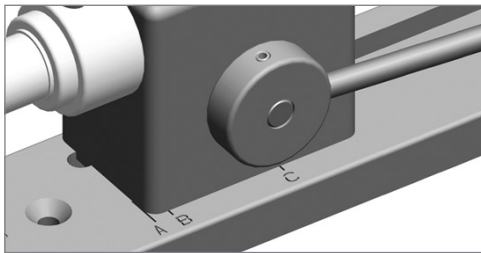

- A. The nut resides on the outside of the clamp.
- B. The nut resides between the clamp and the mandrel.
- C. Minimum tube unions used to install insert in second side.

2. Verify the correct size mandrel and clamp inserts are installed for the desired tube size. Refer to the PrimeLock Accessories on www.entegris.com.

NOTE: The mandrel is removed by pulling the retaining pin and sliding it off the tool. Clamp inserts are removed by pulling them out of the clamp assembly.

3. Slide the insert onto the mandrel as shown.

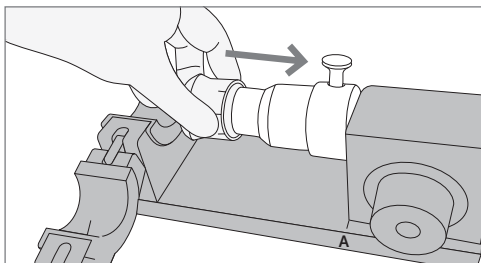

4. Verify the insert has been properly placed onto the mandrel. The installation indication lines on the insert are closest to the shoulder of the mandrel.

For 1/4" insert installation, the insert does not have installation indications lines and can be installed in either direction.

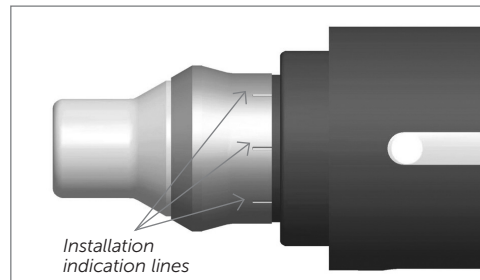

Correct installation of insert.

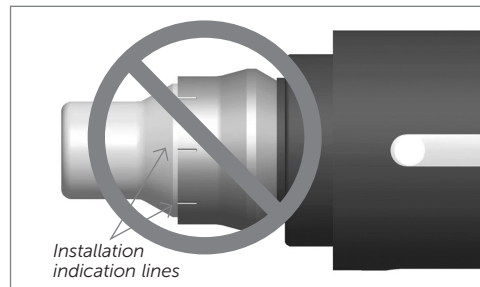

Incorrect installation of insert.

5. Insert the cut end of the tubing through the PrimeLock nut.

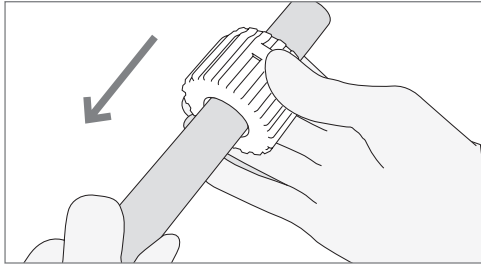

6. Insert the tubing assembly into the clamp.

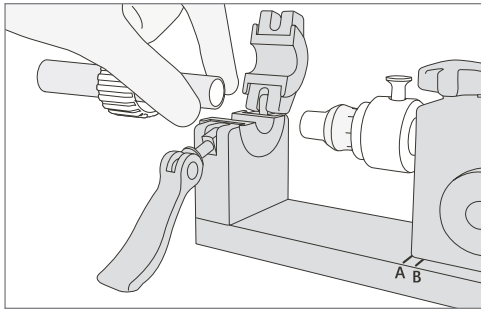

7. Slide the tube onto the mandrel until it stops.

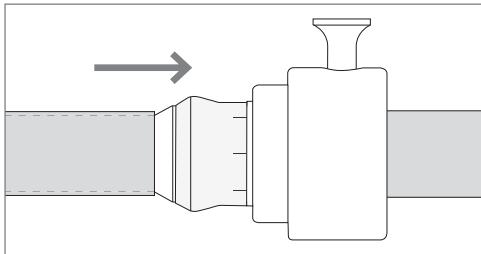

8. Clamp the tube in place.

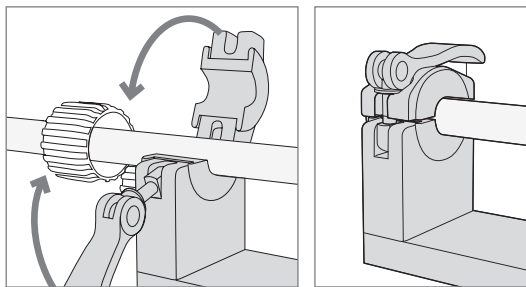

9. If the tubing is not held firmly, clean the tubing and clamp with an IPA wipe.

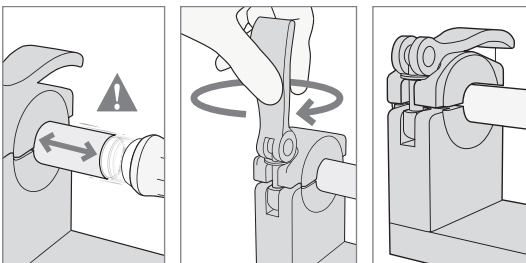

10. Rotate the handle, driving the insert into the tube until the tube contacts the mandrel shoulder.

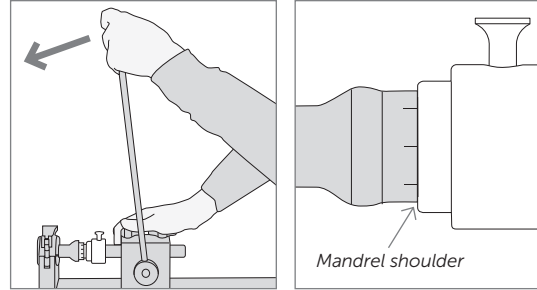

11. For 3/8" to 1" sizes, retract the handle when the insert is installed into the tube. Unclamp the tube.

FOR 1/4" INSTALLATION ONLY

⚠ CAUTION! Failure to follow 1/4" insert instructions may result in the insert remaining on the mandrel after installation.

12. For the 1/4" insert installation, there are two methods to properly eject the mandrel from the tube assembly. See steps 12a or 12b and 12c.

- 12a. Hold the ejection collar as you retract the handle until the mandrel is free from the tube assembly.

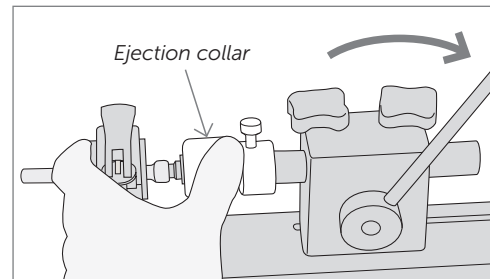

OR

- 12b. Unclamp the tube; then retract the handle.

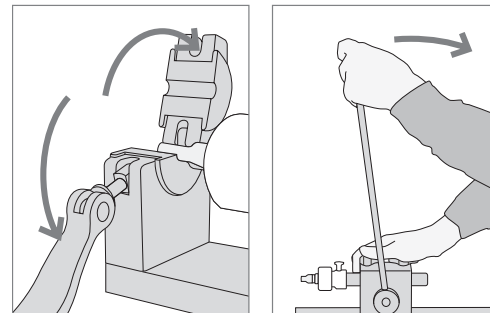

12c. Push the ejection collar forward until the tube assembly is ejected from the mandrel.

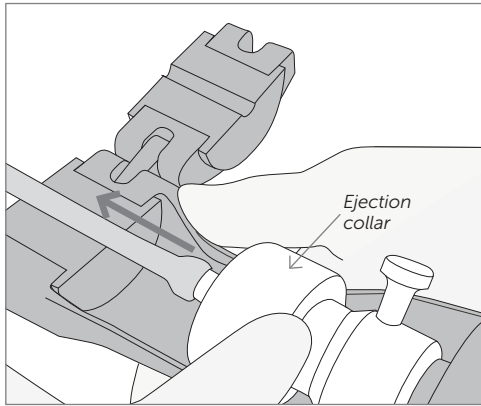

13. Verify the insert has been properly installed into the end of the tube. The insert has molded indication lines for gauging proper installation in the tube. For correct installation, the tubing will cover all or at least a portion of the indication lines. The insert does not need to be pushed fully into the tube.

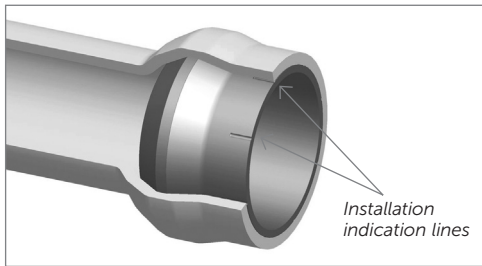

Correct installation of insert.

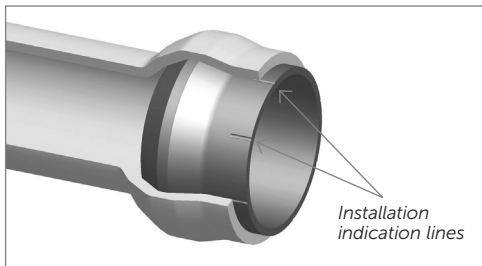

Correct installation of insert.

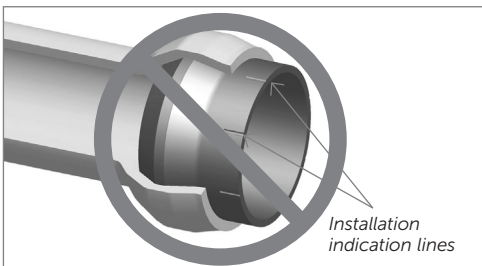

Incorrect installation of insert.

For the 1/4" insert installation, the insert must be pressed entirely into the tube, at a minimum flush with the end of the tube or until the tube contacts the mandrel shoulder.

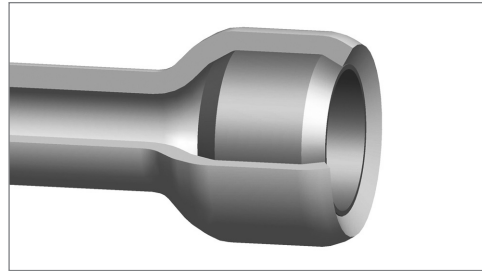

Correct installation of insert.

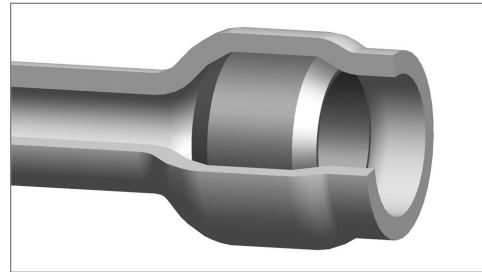

Correct installation of insert.

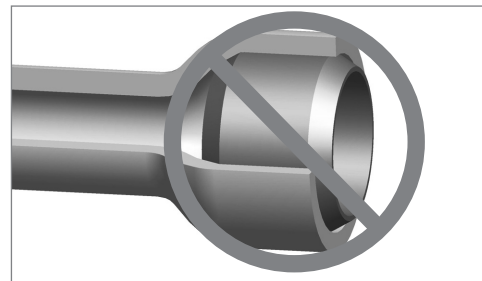

Incorrect installation of insert.

14. Slide the tubing assembly onto the fitting.

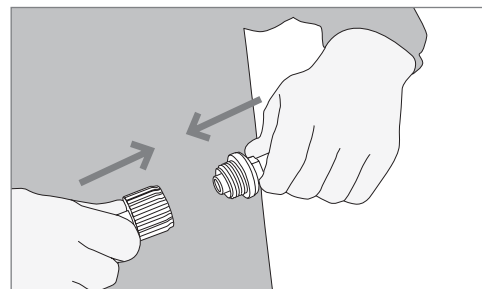

15. Start by hand-tightening the nut.

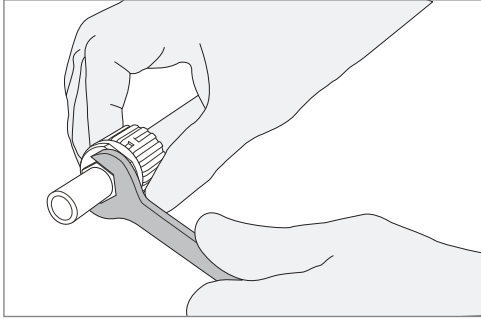

16. Place the PrimeLock wrench over the ribs of the fitting nut and rotate clockwise. Tighten the nut until the connection verification ring creates audible clicks and the leading edge of the nut travels under the connection verification ring.

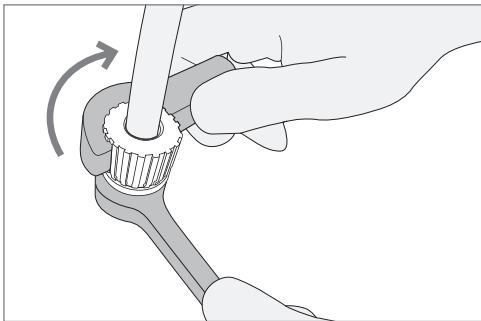

NOTE: Do not overtighten to the point where the nut bottoms out on the fitting body.

17. If there is excessive background noise, the connection can be verified by looking at the position of the connection verification ring relative to the nut.

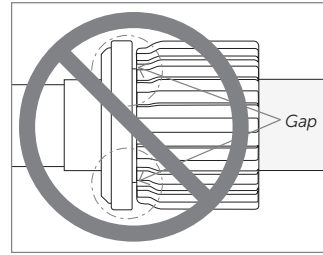

Incorrect tightening of the fitting – additional tightening required.

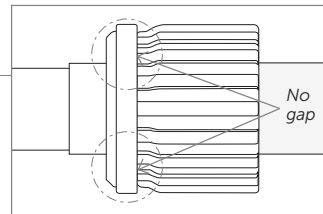

Correct tightening of the fitting.

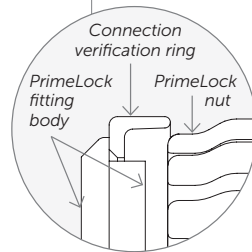

Initial tightening of the fitting – nut travels underneath connection verification ring.

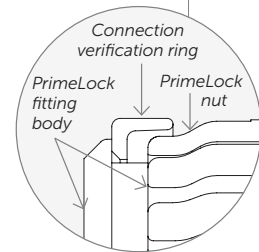

Maximum tightening limit – nut bottoms out on the fitting body.

CAUTION! Do not retighten the fitting while the fitting assembly is above 30°C (86°F) or in a pressurized condition.

WHEN reassembling the fitting, tighten the nut an additional 1/4- to 1/3-turn beyond the initial tightening position, or until a leak-free seal is made.

FITTING DISASSEMBLY

Care must be taken when disassembling PrimeLock fittings. Follow these instructions precisely to avoid fitting disassembly issues.

As shown in the example below, rotate the tube in a circular motion and slowly extract the tube with the insert from the nose of the PrimeLock fitting.

If the tube is not rotated, the insert may disengage from the inside of the tubing and remain on the nose of the fitting.

Follow these steps to properly remove the tube from a fully installed PrimeLock fitting:

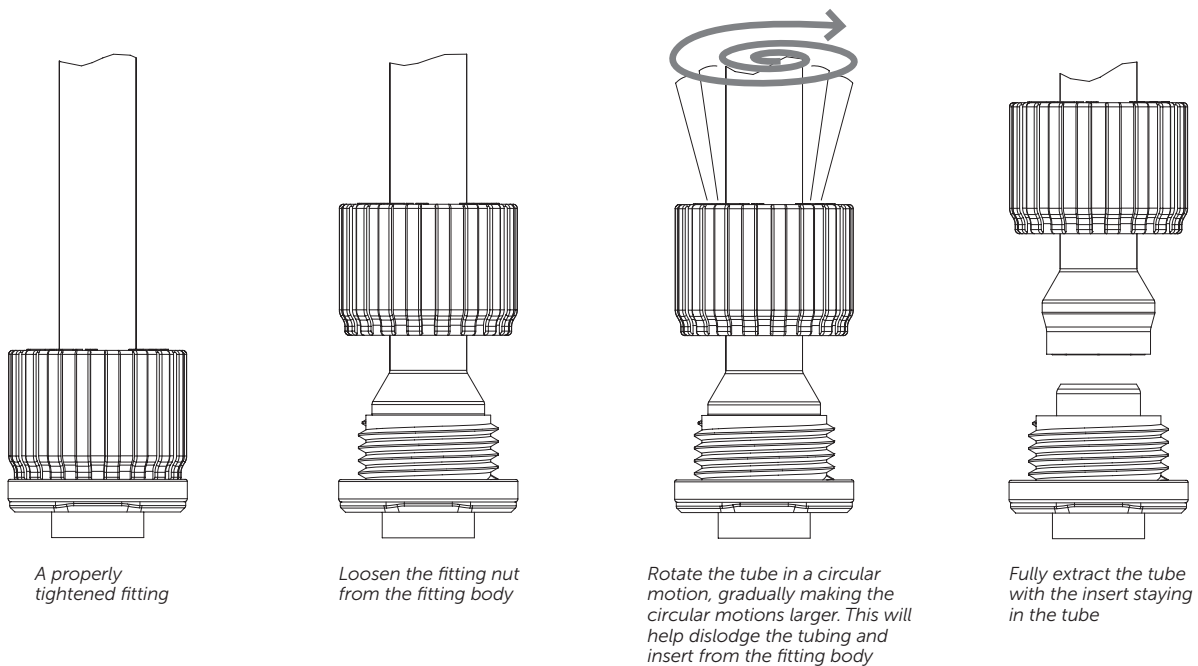

If the insert remains on the nose of the PrimeLock fitting, carefully remove the insert without damaging the fitting nose and discard. Install a new insert into the tube. Reusing a PrimeLock insert may cause sealing issues.

PRIMELOCK INSERT INSTALLATION TOOLS

A complete set of tools is available on our website. Please visit PrimeLock Accessories on www.entegris.com.

FOR MORE INFORMATION

Please call your Regional Customer Service Center today to learn what Entegris can do for you. Visit entegris.com and select the Contact Us link to find the customer service center nearest you.

TERMS AND CONDITIONS OF SALE

All purchases are subject to Entegris' Terms and Conditions of Sale. To view and print this information, visit entegris.com and select the Terms & Conditions link in the footer.



Corporate Headquarters
129 Concord Road
Billerica, MA 01821
USA

Customer Service
Tel +1 952 556 4181
Fax +1 952 556 8022
Toll Free 800 394 4083

Entegris®, the Entegris Rings Design™, Pure Advantage™, and other product names are trademarks of Entegris, Inc. as listed on entegris.com/trademarks. All third-party product names, logos, and company names are trademarks or registered trademarks of their respective owners. Use of them does not imply any affiliation, sponsorship, or endorsement by the trademark owner.

©2012-2018 Entegris, Inc. | All rights reserved. | Printed in the USA | 3110-6128ENT-0218